

2 エキスパンション用ジョイント

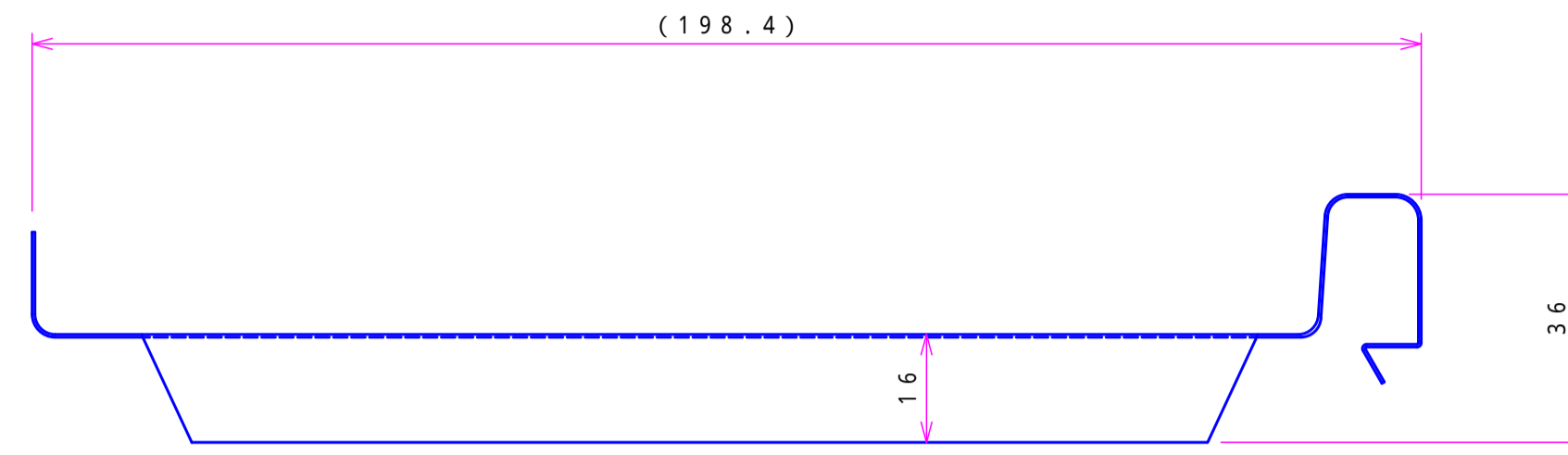

1 エキスパンション

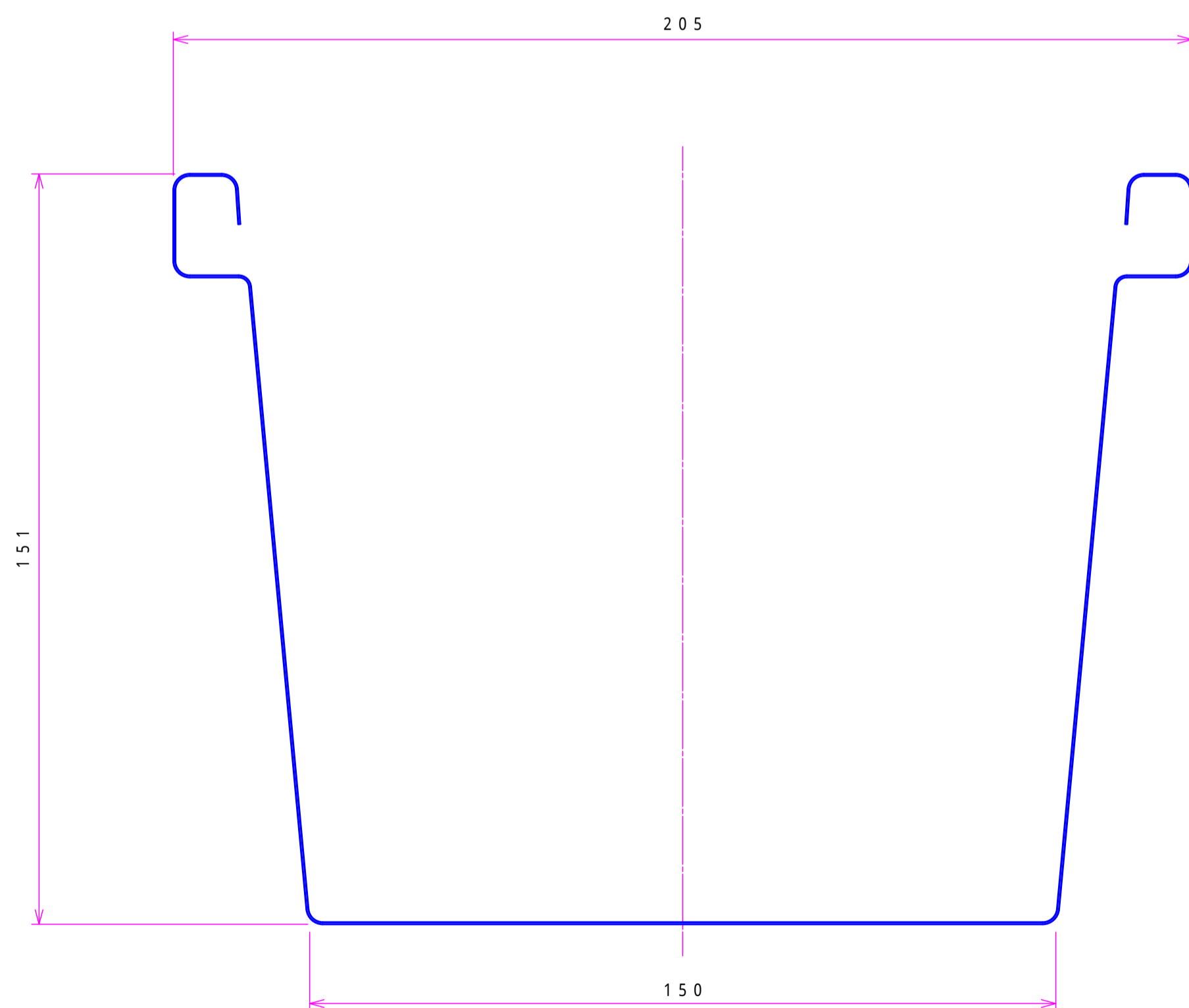
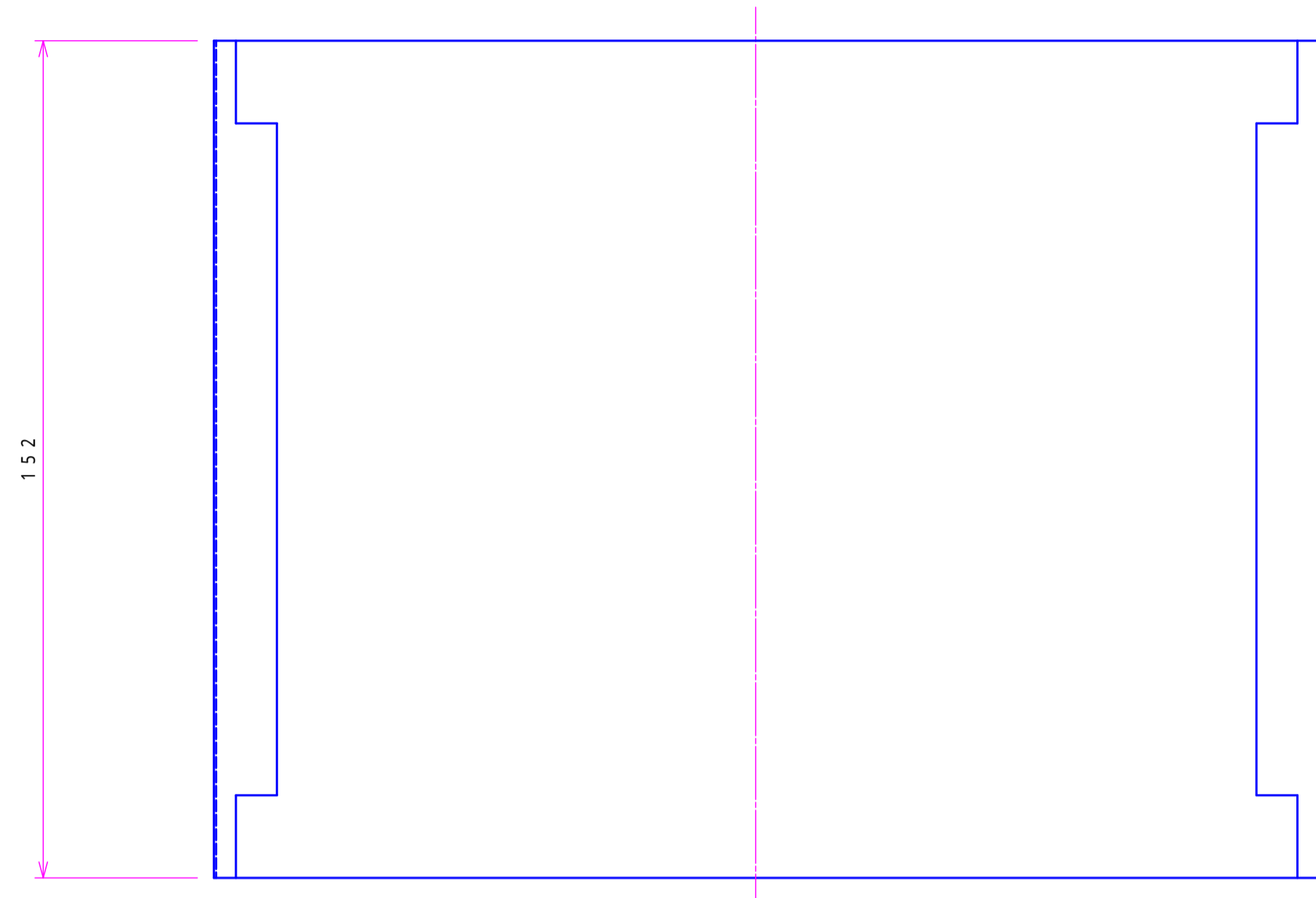
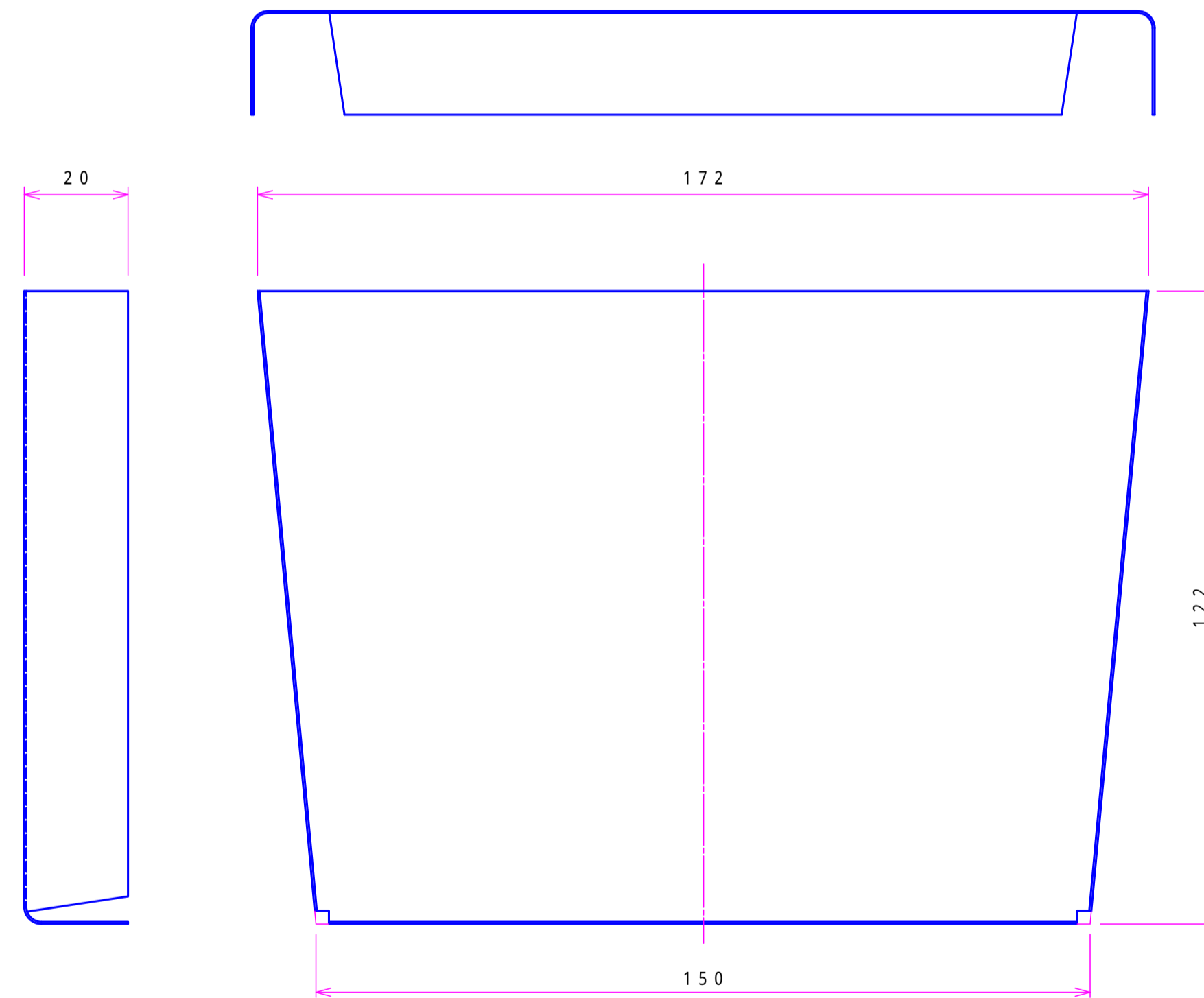
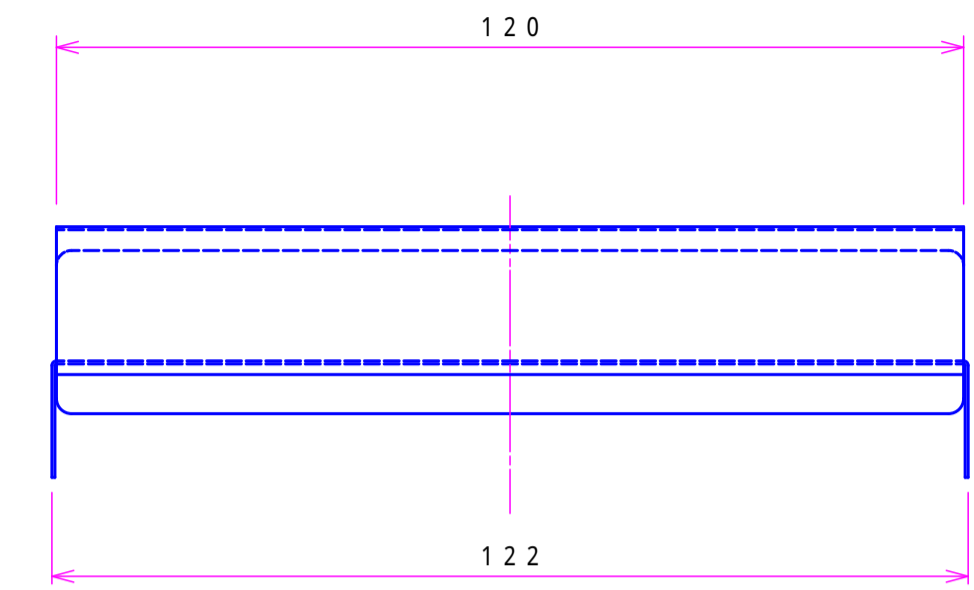

3 エキスパンション用簡易水止め

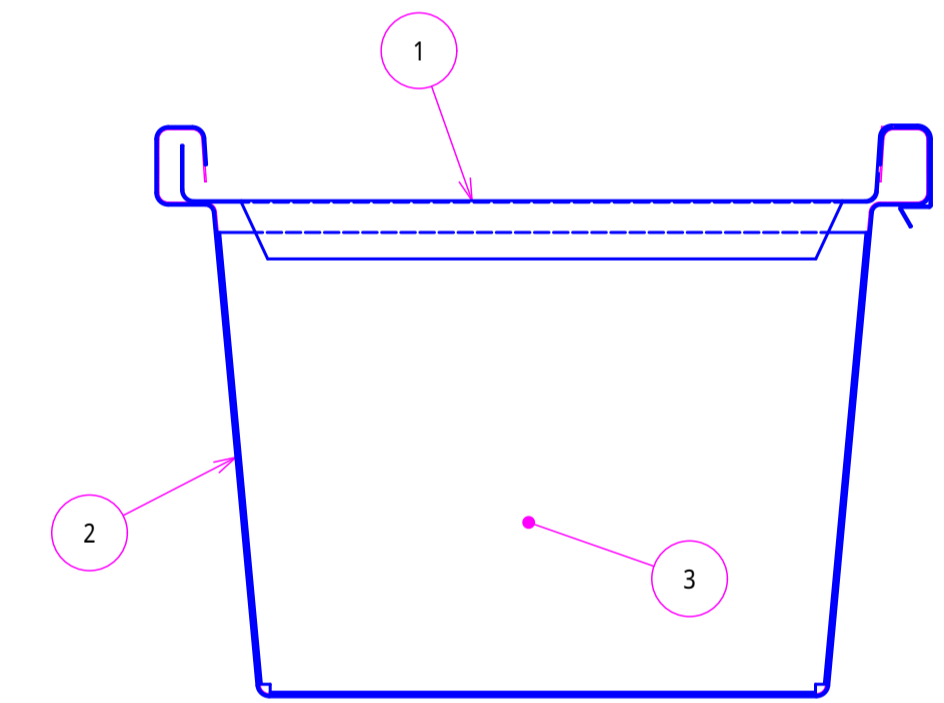

施工組立図  
(S=1/2)

(t=0.5)